

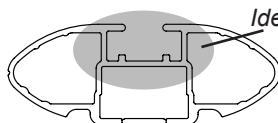

# DK137 Rhino-Rack VA, Aero, Euro & HD crossbar instruction

## IDENTIFICATION CHART



VA crossbar

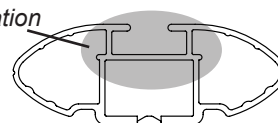

AERO crossbar

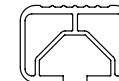

EURO crossbar

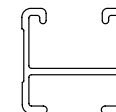

HD crossbar

### FRONT CROSSBAR

### REAR CROSSBAR

| Vehicle                                   | Date        | Crossbar | FRONT CROSSBAR         |                       |                                   |                                   |                            | REAR CROSSBAR              |                       |                      |                                   |                                   |                            |                            |
|---|-------------|----------|------------------------|-----------------------|-----------------------------------|-----------------------------------|----------------------------|----------------------------|-----------------------|----------------------|-----------------------------------|-----------------------------------|----------------------------|----------------------------|
|   |             |          | Front Right Pad/ Clamp | Front Left Pad/ Clamp | Measurement strip length per side | Measurement strip length per side | Measurement Distance ( x ) | Foot plate arrow direction | Rear Right Pad/ Clamp | Rear Left Pad/ Clamp | Measurement strip length per side | Measurement strip length per side | Measurement Distance ( x ) | Foot plate arrow direction |
| Toyota Corolla 5dr hatch ZRE152R (AU/ NZ) | 05/07-09/12 | 1180mm   | M415 SUB0256           | M414 SUB0256          | 198mm                             | 143mm                             | 964mm / 37,61/64"          | OUT                        | M416 SUB0256          | M416 SUB0256         | 190mm                             | 135mm                             | 948mm / 37,21/64"          | OUT                        |
|   |             |          | Arrow OUT              |                       |                                   |                                   |                            |                            | Arrow OUT             |                      |                                   |                                   |                            |                            |
| Toyota Auris 5dr hatch (UK/ EUR)          | 07-12       | 1180mm   | M415 SUB0256           | M414 SUB0256          | 198mm                             | 143mm                             | 964mm / 37,61/64"          | OUT                        | M416 SUB0256          | M416 SUB0256         | 190mm                             | 135mm                             | 948mm / 37,21/64"          | OUT                        |
|   |             |          | Arrow OUT              |                       |                                   |                                   |                            |                            | Arrow OUT             |                      |                                   |                                   |                            |                            |
| Toyota Auris 5dr hatch (ZA)               | 07-12       | 1180mm   | M415 SUB0256           | M414 SUB0256          | 198mm                             | 143mm                             | 964mm / 37,61/64"          | OUT                        | M416 SUB0256          | M416 SUB0256         | 190mm                             | 135mm                             | 948mm / 37,21/64"          | OUT                        |
|   |             |          | Arrow OUT              |                       |                                   |                                   |                            |                            | Arrow OUT             |                      |                                   |                                   |                            |                            |
|   |             |          |                        |                       |                                   |                                   |                            |                            |                       |                      |                                   |                                   |                            |                            |
|   |             |          |                        |                       |                                   |                                   |                            |                            |                       |                      |                                   |                                   |                            |                            |



# DK137 Rhino-Rack VA, Aero, Euro & HD crossbar instruction

**Measurement A:** CENTRE of door jamb to CENTRE arrow of leg foot plate.

**Measurement B:** CENTRE of Front leg foot plate arrow to CENTRE of Rear leg foot plate arrow.

**Carrying capacity:** Roof rack is rated to 75kg. Please refer to manufacturers handbook for your vehicles maximum roof load capacity. Always use the lower of the two figures.

If your vehicle is not listed on this fitting instruction please refer to your countries Rhino-Rack web site for the latest information.

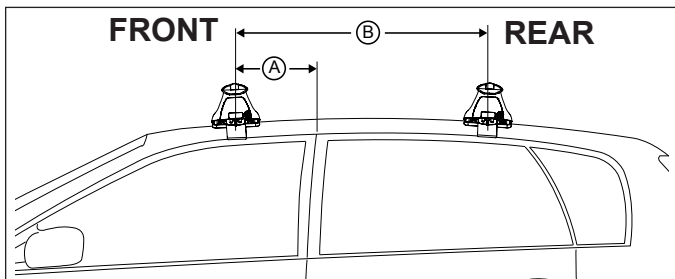
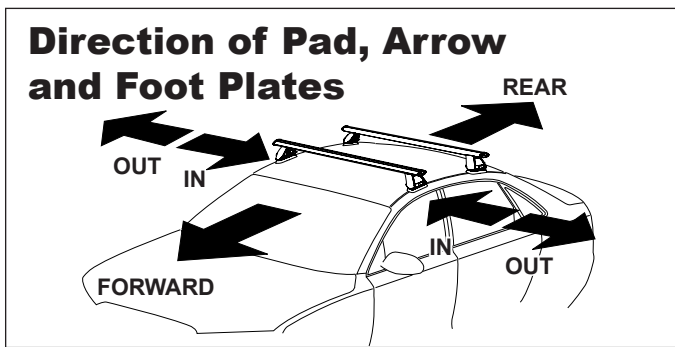
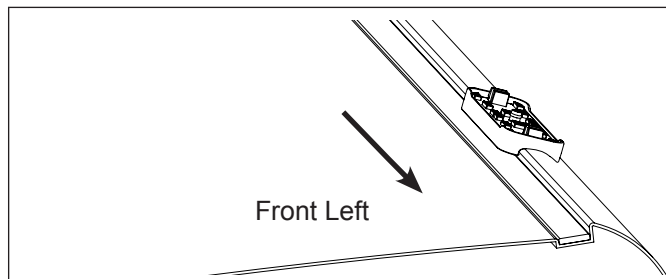
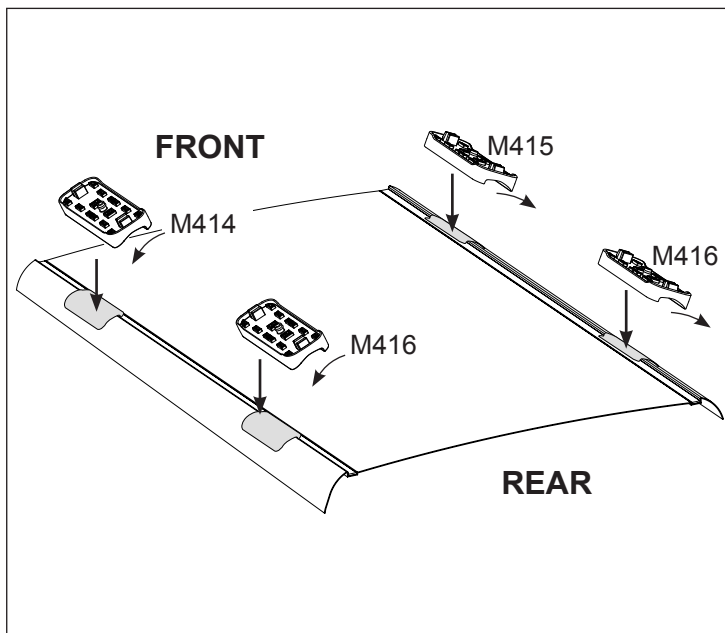

| VEHICLE                                  | Date        | Measurement A   | Measurement B    | Load Rating (includes racks 5kg/11lbs) |
|--|-------------|-----------------|------------------|--|
| Toyota Corolla 5dr hatch ZRE152R (AU/NZ) | 05/07-09/12 | 260mm / 10,1/4" | 700mm / 27,9/16" | 75kg / 165lbs                          |
| Toyota Auris 5dr hatch (UK/EUR)          | 07-12       | 260mm / 10,1/4" | 700mm / 27,9/16" | 75kg / 165lbs                          |
| Toyota Auris 5dr hatch (ZA)              | 07-12       | 260mm / 10,1/4" | 700mm / 27,9/16" | 75kg / 165lbs                          |
|  |             |                 |                  |  |
|  |             |                 |                  |  |
|  |             |                 |                  |  |