

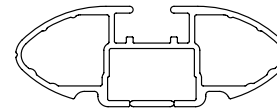

CROSSBAR IDENTIFICATION

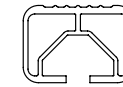

VA crossbar



EURO crossbar

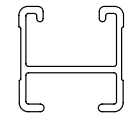

HD crossbar

| Vehicle | Date | Crossbar | FRONT CROSSBAR | | | | | REAR CROSSBAR | | | | | | |
|---------------------------------|-------|----------|-----------------------|----------------------|-----------------------------------|-----------------------------------|----------------------------|----------------------------|----------------------|---------------------|-----------------------------------|-----------------------------------|----------------------------|----------------------------|
| | | | Front Right Pad/Clamp | Front Left Pad/Clamp | Measurement strip length per side | Measurement strip length per side | Measurement Distance (x) | Foot plate arrow direction | Rear Right Pad/Clamp | Rear Left Pad/Clamp | Measurement strip length per side | Measurement strip length per side | Measurement Distance (x) | Foot plate arrow direction |
| Audi A3 5dr hatch | 04-12 | 1180mm | M366 SUB0144 | M366 SUB0144 | 202mm | 147mm | 972mm / 38,17/64" | OUT | M366 SUB0144 | M366 SUB0144 | 176mm | 121mm | 920mm / 36,7/32" | OUT |
| | | | Pad Arrow Forward | | | | | | Pad Arrow Forward | | | | | |
| Holden Jackaroo 4dr wagon | 98-01 | 1375mm | M366 SUB0144 | M366 SUB0144 | 165mm | 110mm | 1093mm / 43,1/32" | OUT | M366 SUB0144 | M366 SUB0144 | 161mm | 106mm | 1085mm / 42,23/32" | OUT |
| | | | Pad Arrow Forward | | | | | | Pad Arrow Forward | | | | | |
| Mitsubishi Grandis 4dr wagon | 04-10 | 1260mm | M366 SUB0144 | M366 SUB0144 | 201mm | 88mm | 1050mm / 41,11/32" | OUT | M366 SUB0144 | M366 SUB0144 | 202mm | 89mm | 1052mm / 41,27/64" | OUT |
| | | | Pad Arrow Forward | | | | | | Pad Arrow Forward | | | | | |
| Kia Rondo/ Kia Carens 4dr wagon | 07-13 | 1260mm | M366 SUB0144 | M366 SUB0144 | 185mm | 72mm | 1018mm / 40,5/64" | OUT | M366 SUB0144 | M366 SUB0144 | 177mm | 64mm | 1002mm / 39,29/64" | OUT |
| | | | Pad Arrow Forward | | | | | | Pad Arrow Forward | | | | | |



CROSSBAR IDENTIFICATION

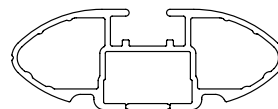

VA crossbar

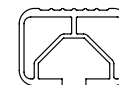

EURO crossbar

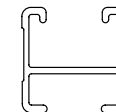

HD crossbar

| Vehicle | Date | Crossbar | FRONT CROSSBAR | | | | | REAR CROSSBAR | | | | | | |
|-----------------------------|-------|----------|-----------------------|----------------------|-----------------------------------|-----------------------------------|----------------------------|----------------------------|----------------------|---------------------|-----------------------------------|-----------------------------------|----------------------------|----------------------------|
| | | | Front Right Pad/Clamp | Front Left Pad/Clamp | Measurement strip length per side | Measurement strip length per side | Measurement Distance (x) | Foot plate arrow direction | Rear Right Pad/Clamp | Rear Left Pad/Clamp | Measurement strip length per side | Measurement strip length per side | Measurement Distance (x) | Foot plate arrow direction |
| Ford Fiesta 5dr hatch WS-WZ | 09- | 1180mm | M366 SUB0144 | M366 SUB0144 | 199mm | 144mm | 966mm / 38,1/32" | OUT | M366 SUB0144 | M366 SUB0144 | 175mm | 120mm | 918mm / 36,9/64" | OUT |
| | | | Pad Arrow Forward | | | | | | Pad Arrow Forward | | | | | |
| BMW 5 Series 4dr sedan E60 | 03-10 | 1260mm | M366 SUB0144 | M366 SUB0144 | 184mm | 71mm | 1016mm / 40" | OUT | M366 SUB0144 | M366 SUB0144 | 185mm | 72mm | 1018mm / 40,5/64" | OUT |
| | | | Pad Arrow Forward | | | | | | Pad Arrow Forward | | | | | |
| Dodge Avenger 4dr sedan | 08-14 | 1260mm | M366 SUB0144 | M366 SUB0144 | 194mm | 81mm | 1036mm / 40,25/32" | OUT | M366 SUB0144 | M366 SUB0144 | 189mm | 76mm | 1026mm / 40,25/64" | OUT |
| | | | Pad Arrow Forward | | | | | | Pad Arrow Forward | | | | | |
| Toyota Tacoma Access Cab | 05-15 | 1375mm | M366 SUB0144 | M366 SUB0144 | 163mm | 108mm | 1089mm / 42,7/8" | OUT | M366 SUB0144 | M366 SUB0144 | 153mm | 98mm | 1069mm / 42,3/32" | OUT |
| | | | Pad Arrow Forward | | | | | | Pad Arrow Forward | | | | | |
| Toyota Tacoma Regular Cab | 05-15 | 1375mm | M366 SUB0144 | M366 SUB0144 | 164mm | 109mm | 1091mm / 42,61/64" | OUT | - | - | - | - | - | - |
| | | | Pad Arrow Forward | | | | | | - | | | | | |



Rhino Rack 2500 Series - DK046/ DK046H instruction

CONTROLLED

Measurement A: CENTRE of door jamb to CENTRE arrow of leg foot plate.

Measurement B: CENTRE of Front leg foot plate arrow to CENTRE of Rear leg foot plate arrow.

Carrying capacity: Roof rack is rated to 75kg. Please refer to manufacturers handbook for your vehicles maximum roof load capacity. Always use the lower of the two figures.

If your vehicle is not listed on this fitting instruction please refer to your countries Rhino-Rack web site for the latest information.

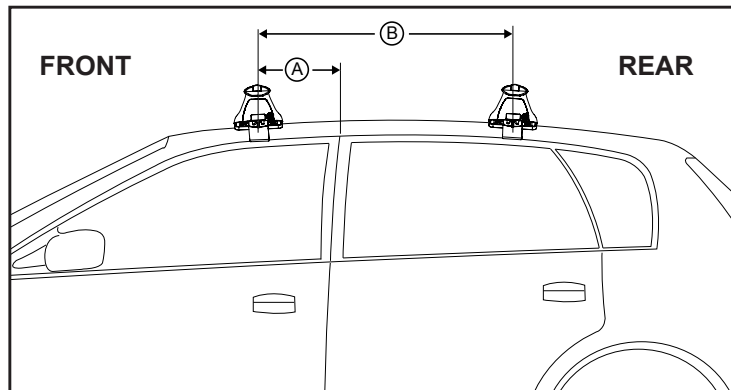
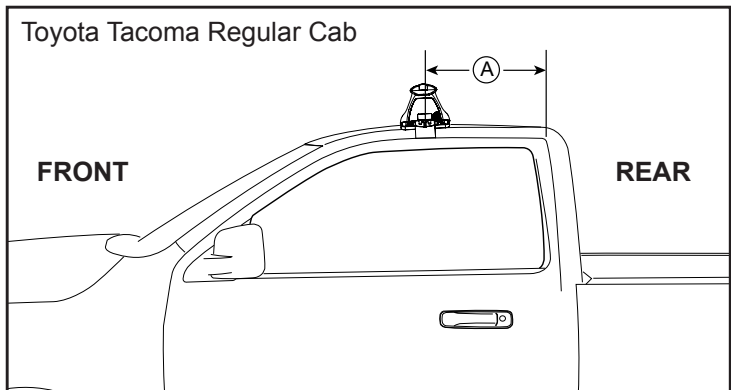
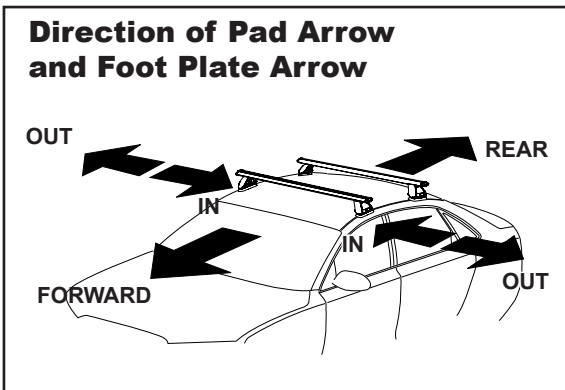

| VEHICLE | Date | Measurement A | Measurement B | Load Rating (includes racks 5kg/ 11lbs) |
|---------------------------------|-------|-------------------|-------------------|--|
| Audi A3 5dr hatch | 04-12 | 300mm / 11,13/16" | 750mm / 29,17/32" | 75kg / 165lbs |
| Holden Jackaroo 4dr wagon | 98-01 | 250mm / 9,27/32" | 850mm / 33,15/32" | 75kg / 165lbs |
| Mitsubishi Grandis 4dr wagon | 04-10 | 50mm / 1,31/32" | 750mm / 29,17/32" | 60kg / 132lbs |
| Kia Rondo/ Kia Carens 4dr wagon | 07-13 | 200mm / 7,7/8" | 750mm / 29,17/32" | 75kg / 165lbs |
| Ford Fiesta 5dr hatch WS-WZ | 09- | 200mm / 7,7/8" | 700mm / 27,9/16" | 75kg / 165lbs |
| BMW 5 Series 4dr sedan E60 | 03-10 | 250mm / 9,27/32" | 710mm / 27,61/64" | 75kg / 165lbs |
| Dodge Avenger 4dr sedan | 08-14 | 300mm / 11,13/16" | 700mm / 27,9/16" | 75kg / 165lbs |
| Toyota Tacoma Access Cab | 05-15 | 280mm / 11,1/32" | 650mm / 25,19/32" | 75kg / 165lbs |
| Toyota Tacoma Regular Cab | 05-15 | 280mm / 11,1/32" | - | 30kg / 66lbs |